

CARACTERÍSTICAS / FEATURES

Material hormigón petra 1
Acabado decapado e hidrofugado
Dimensiones Ø110, h. 100 cm.
Color ver carta de colores
Fijación anclado mediante varilla roscada y resina epoxy
Peso 520 Kg
Bulto 120 x 100 x 115 cm
Peso bulto 535 Kg

Material precast concrete petra 1
Finish scaled and waterproofed
Dimensions Ø110, h. 100 cm
Colour see colour catalogue
Fixing anchored with metal rod and epoxy resin
Weight 520 Kg
Package 120 x 100 x 115 cm
Weight package 535 Kg

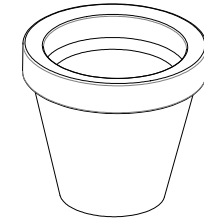

GEOMETRIA / GEOMETRY

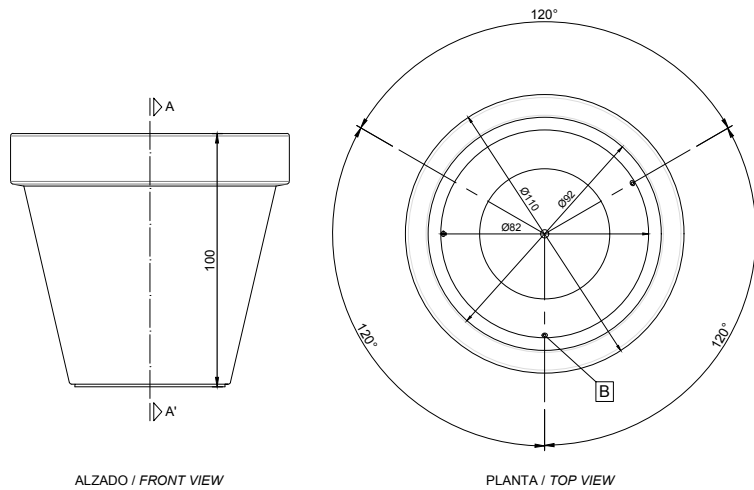

- barra corrugada / corrugated rod [A]
- casquillo roscado / thread sleeve [B]
- cáncamo / eyebolt [C]
- tapa / stopper [D]
- varilla roscada / thread the rod [E]

SISTEMA DE FIJACIÓN / ANCHORAGE SYSTEM

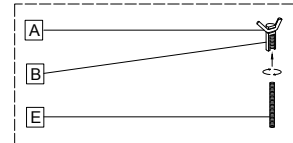

SISTEMA DE ELEVACIÓN / LIFTING SYSTEM

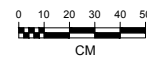
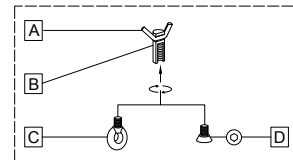

MANIPULACIÓN E INSTALACIÓN / HANDLING AND INSTALLATION

- 1 extraer tapa / extract stopper
- 2 perforar agujero y verter resina epoxy drill hole and pour resin epoxy

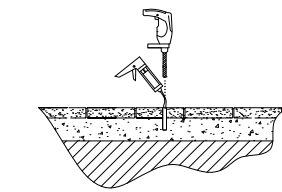
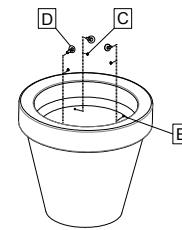

- 3 elevar, enroscar la varilla lift, thread the rod

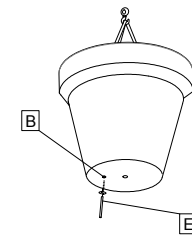

- 4 insertar la varilla en el agujero insert metal rod in hole

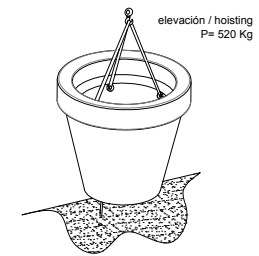

elevación / hoisting
P= 520 Kg

ESPECIFICACIONES / SPECIFICATIONS

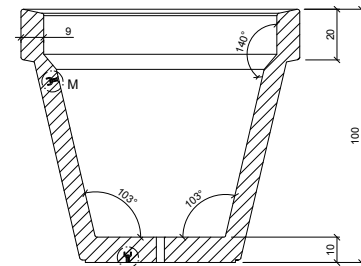

SECCIÓN A-A' / SECTION A-A'

- [B] Casquillo M16 acero zincado alta precisión
Galvanized steel pipe M16 high precision
- [A] Barra corrugada acero negro Ø6
Corrugated rod black steel Ø6
- [D] Tapa - Tornillo avellanado M16
Stopper - Countersunk screw M16

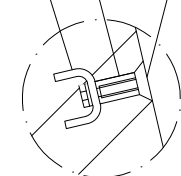

DETALLE M / DETAIL M

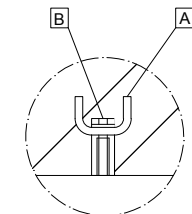

DETALLE N / DETAIL N