

CARACTERÍSTICAS / FEATURES

Material hormigón Petra 1
Acabado decapado e hidrofugado
Dimensiones l. 184, a. 179, h. 46 cm
Color ver carta de colores
Fijación apoyado por su propio peso o mediante resina epoxi

Material precast concrete Petra 1
Finish etched and waterproofed
Dimensions l. 184, w. 179, h. 46 cm
Colour see colour catalogue
Fixing resting on the ground or with epoxy resin
Weight 1270 Kg
Pallet 200 x 200 cm

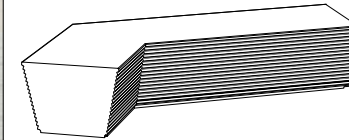

GEOMETRIA / GEOMETRY

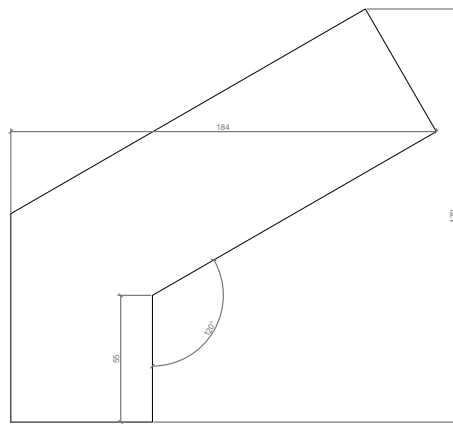

VISTA SUPERIOR / TOP VIEW

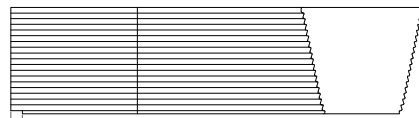

PERFIL / RIGHT SIDE

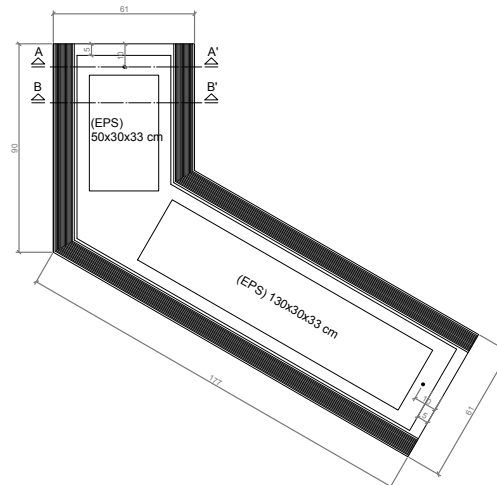

VISTA INFERIOR / BOTTOM VIEW

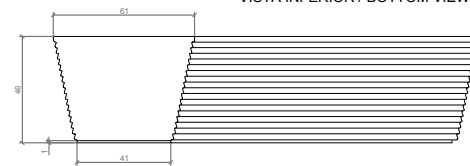

ALZADO / FRONT VIEW ESC. 1:20

ESPECIFICACIONES / SPECIFICATIONS

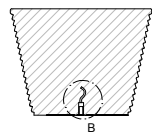

SECCIÓN A-A' / SECTION A-A'

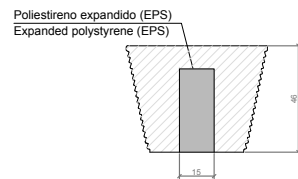

SECCIÓN B-B' / SECTION B-B'

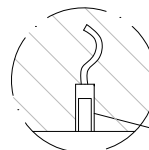

DETALLE B / DETAIL B

Casquillo M12
 Tubo acero zincado alta precisión
 Galvanized steel threaded sleeve M12 high precision

MANIPULACIÓN E INSTALACIÓN / HANDLING AND INSTALLATION

- 1 Elevar y enroscar la varilla
 Lift and thread the rod

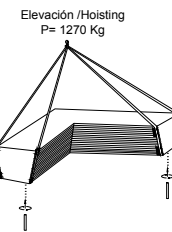
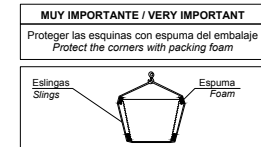

- 2 Perforar dos agujeros / Drill two holes

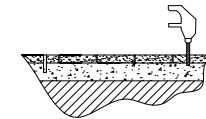

- 3 Verter resina epoxy / Pour resin epoxy

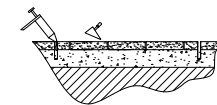

- 4 Insertar la varilla en el agujero
 Insert metal rod in hole

